



Factory Service Bulletin

2500 WALDEN AVENUE, BUFFALO, N.Y. 14225 (716) 681-7242
p/a WAALHAVEN Z.Z. 48, 3088 H.J. ROTTERDAM, THE NETHERLANDS

SUBJECT: MEMORYMOOG AUTOTUNE UPDATE BULLETIN: 840 DATE: 10/6/83
Serial numbers below 2723
Software Revision 2.4 (C, O, ENTER displays 83)
Kit Part Number 997-044667-101

NOTE: This is a non-warranty update. Customers with serial numbers below 1212 AND 1.4 or 1.5 software may elect to apply a one-time no-charge software update by receiving the Autotune kit under warranty. However, labor is NOT covered.

This update improves the AUTOTUNE range, consistency and accuracy. It will adjust tuning for plus or minus two semitones, compensate for each note on the keyboard (true scale correction) and tune each oscillator with a reiterative feedback loop. The AUTOTUNE program takes approximately sixteen seconds versus older ten second versions. This update is a prerequisite for inclusion in the SEQUENCER/MIDI modification. The AUTOTUNE update is estimated to take three to four hours.

NOTE: Bulletins 834, 837 and 838 MUST be installed prior to this update for the best possible tuning stability.

The modification has eight main sections, however, before proceeding with these changes, it is strongly suggested that ANY NECESSARY REPAIRS ARE COMPLETED FIRST (excluding tuning) so that any troubleshooting is not unduly complicated by what follows here:

MODIFICATION SUMMARY

- 1) CASSETTE - SAVE and VERIFY customer presets.
- 2) DMUX BOARD - change 18 resistors, 13 capacitors and add a jumper.
- 3) DIGITAL BOARD - change EPROMs and add a resistor.
- 4) COMMON ANALOG BOARD - add two jumpers and a small buffer board.
- 5) HARNESS - reroute one wire.
- 6) CASSETTE - LOAD customer presets.
- 7) TUNING - rerange each oscillator and, in some cases, adjust the master oscillator summers.
- 8) SCHEMATICS - update layout and circuit information.

CASSETTE - OWNER'S PRESETS

The Memorymoog AUTOTUNE update increases the AUTOTUNE range to "16 bits" of resolution. This causes the presets and SECURITY CODE to change unpredictably, therefore, it is necessary to SAVE the existing presets on a cassette tape (C,1,ENTER), and VERIFY the cassette (C,3,ENTER), with the "original" EPROMs as your first procedure.

DMUX MODIFICATIONS - BOARD #5

Referring to the disassembly procedure on page 131 of the service manual, remove the eight (8) DMUX board mounting screws, the nine (9) base retaining screws and three (3) back panel screws.

Once the Memorymoog is open, remove the four (4) front screws on the DIGITAL/Common ANALOG boards and the four (4) front screws on the VOICE CARD stacks to allow the boards to hinge back.

Referring to the enclosed diagrams, disconnect the following connectors from the DMUX board: S54, S58, S59, (3) P-512 and P-519. Then disconnect VOICE CARD connectors S-11 and P17 and lastly, disconnect the keyboard connector P-121.

Once the screws and connectors are removed from the DMUX/DIGITAL/Common ANALOG stack, rotate the entire assembly forward. (toward the front panel) so the underside of the DMUX board faces outward.

Using a high power 75 watt soldering iron, unsolder, remove and replace the capacitors below. If a high power iron is not available, a variac set at 140 volts in conjunction with a standard 45 watt iron will provide the necessary power to heat these large pads.



REPLACE THESE CAPACITORS WITH 75 WATT SOLDERING IRON
C45, C46, C41, C40, C39, C51, C52, C49 Replace with .047uf capacitors,
C48, C47, C50, C20, C18 (13 capacitors part # 946-041978-473.
mounted left to right and top to bottom).

Then, using a standard 45 watt iron without a variac, unsolder, remove and replace the 115K resistors noted below, perform the jumper modification and proceed with the remainder of the update.

REPLACE EVEN NUMBER RESISTORS FROM R84 THROUGH R118 WITH 45 WATT SOLDERING IRON.

R86, R84, R98, R96, R100, R92, R90
R88, R94, R102, R114, R118, R104,
R112, R108, R110, & R116
(18 resistors as mounted from left to right).

Replace with 17.4K 1% resistors, part number R106, 853-421742-031

Add a 1.5" (38mm) insulated jumper from S-55 pin 2 to U54 pin 2 on the BOTTOM of the board (part number 996-045655-962).

CAUTION: These are in very critical portions of the DMUX board where LEAKAGE DUE TO FLUX WILL DEGRADE THE PERFORMANCE of the pitch port sample and hold circuits. Be sure to clean all flux residue thoroughly after soldering, using isopropyl alcohol or flux remover, a brush and an absorbant tissue to "catch" the fluid - so it does not spread any further than necessary on the board surface.

This completes the DMUX board modifications. Rotate the boards back into normal position and replace the connectors. Resecure the boards later after additional modifications are made to the DIGITAL and COMMON ANALOG BOARDS.

DIGITAL BOARD MODIFICATIONS - BOARD #4

Referring to the enclosed diagram and schematic excerpts, the DIGITAL board requires a trace cut between U26 pin 10 and P47 pin 2. Across this same trace cut, a 33k resistor is to be tack-soldered on the BOTTOM side of the board.

EPROMs U2, U3 and U4 are to be exchanged with versions 2.2 and the old versions returned to MOog in the velostat foam and antistatic bag and shipping carton provided.

- ✓ 33K 5% carbon film resistor
- ✓ EPROM U2 #1 Version 2.4
- ✓ EPROM U3 #2 Version 2.4
- ✓ EPROM U4 #3 Version 2.4

Part # 852-312333-001
Part # 993-045944-124
Part # 993-045944-224
Part # 993-045944-324

COMMON ANALOG BOARD MODIFICATIONS - BOARD #2

Reroute the wiring around U4A as follows on the TOP side of the board:
1) Cut the rear end of resistor R31, the end nearest R17.

- 2) Tack-solder the free end of R31 to the end of a 3" (70mm) insulated jumper wire (1/2 of part number 996-045646-962).
- 3) Tack-solder the other end of the 3" (70mm) jumper to the FRONT side of R75 as shown.

On the schematic, this changes the connection of R31 from its present location at Pin 2 to its new location at Pin 1 of U4A.

Next, change the routing of P24-2 connector on the BOTTOM of the board by tack-soldering a 2.5" (63mm) insulated jumper between P24-2 and S21-2 (1/2 of part number 996-045646-962).

CAUTION: This is a very critical portion of the COMMON ANALOG BOARD where FLUX LEAKAGE WILL DEGRADE PERFORMANCE. Be sure to clean flux residue thoroughly as above.

BUFFER BOARD

Follow the attached installation diagrams.

HARNESS MODIFICATION

Cut the blue wire on the COMMON ANALOG board at the MTA connector P24 Pin 2 and place it into the MTA connector P47 Pin-2 on the DIGITAL board using an AMP tool, small flat blade screwdriver, or pair of small needle-nose pliers.

CASSETTE - LOAD

Due to the software change in the RAM "MEMORY MAP", the RAMS on the DIGITAL BOARD must be re-initialized by momentarily shorting out C13 on the DIGITAL BOARD with the AC power off. C13 is located immediately to the left of the battery. This will force the SECURITY CODE back to "0 0 0 0 DISABLED". Turn the power ON and hit: C,8 ENTER, 0 0 0 0, ENTER. This will "ENABLE" the memory. LOAD back the tape from above by hitting C2 ENTER. Notify the customer that the SECURITY CODE is now back to the original 0 0 0 0 and is ENABLED.

VOICE CARD TUNING

After performing this modification, the C7 software tuning parameters will be sharp from the A's to "PITCH HI". Therefore, simply "RANGE" down all 18 oscillators to the nominal 7F value using the C7 routine. Complete recalibration will NOT be necessary.

COMMON ANALOG TUNING

Between the approximate serial numbers 1600 and 2632 it will be necessary to readjust the OSCILLATOR OFFSET, SUM and OCTAVE trims. Refer to page 149 of the service manual for the proper procedure.

SCHEMATIC UPDATE

Make the above changes in your schematics and the customer's schematics. This completes the modification.

Pg. 23-26 - KEYBOARD, MONO & ARPEGGIATOR MODES

The displaying of keyboard and arpeggiator modes has been changed to make them easier to read and remember. The functions of the various modes, however, have not been changed. The previous modes referred to in the manual and the corresponding new modes are listed below:

KEYBOARD MODES

POLY 1	CYLIC
POLY 2	MEM CYC
POLY 3	RESET
POLY 4	MEM RES

ARPEGGIATOR MODES

MODE 1	UP	U
MODE 2	DWN	U
MODE 3	UP DWN	U
MODE 4	UP	L
MODE 5	DWN	L
MODE 6	UP DWN	L
MODE 7	AUTOTRIG	
MODE 8	1 LAST	U
MODE 9	1 LAST	L

MONO MODES

MONO 1	LATEST
MONO 2	LOW
MONO 3	HIGH

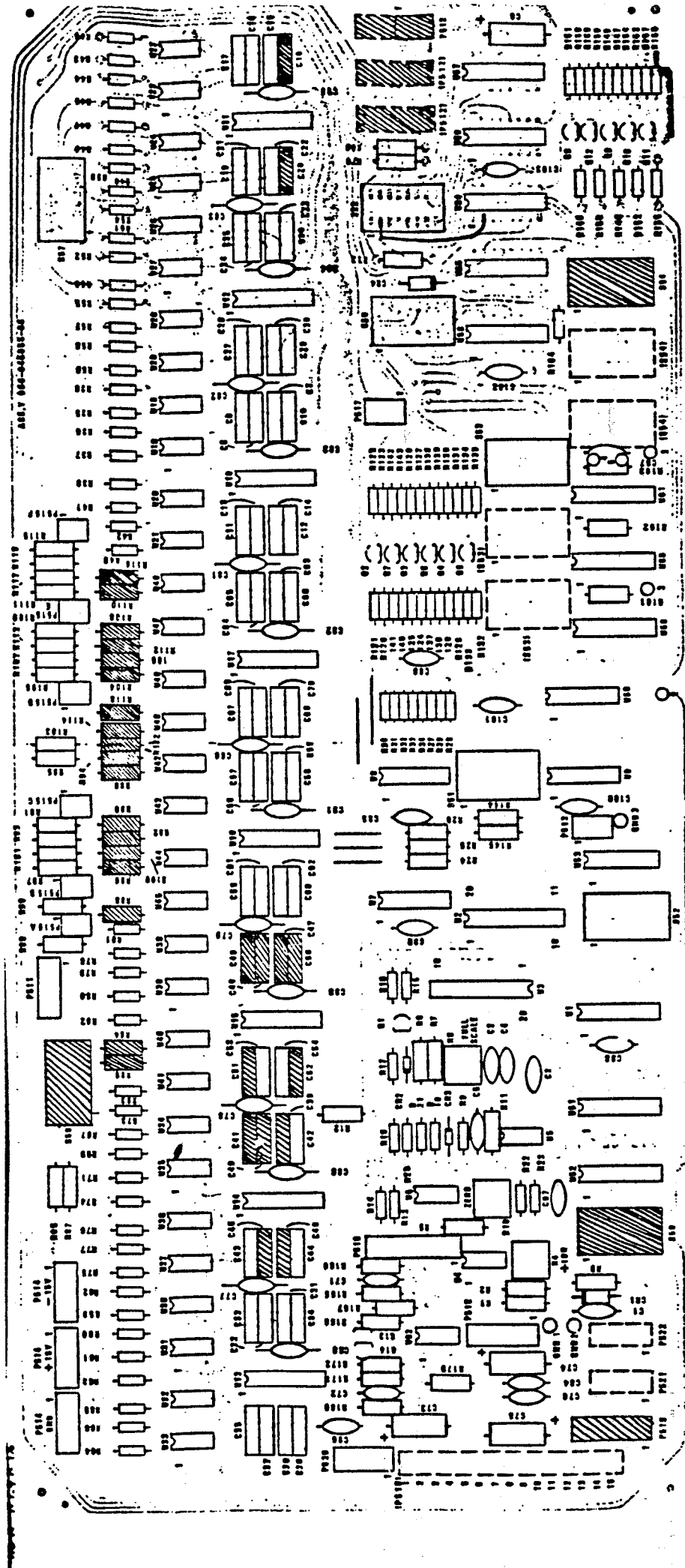

DMUX PRINTED CIRCUIT BOARD (BOARD NO. 5)

DMUX
#5

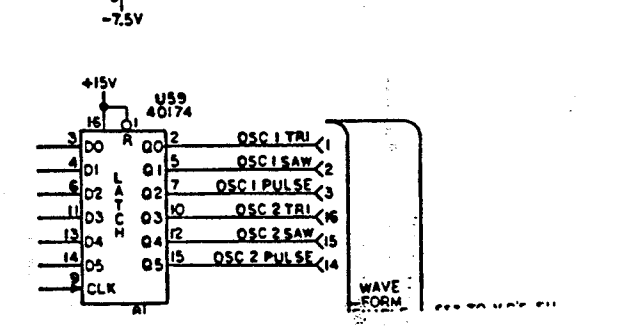
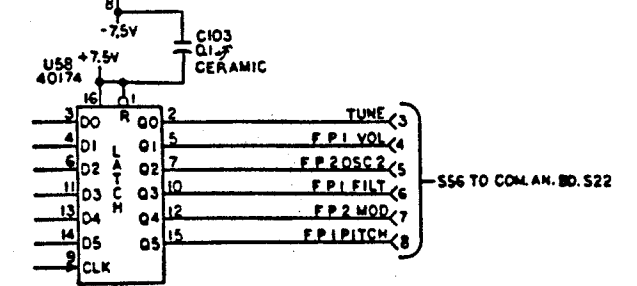
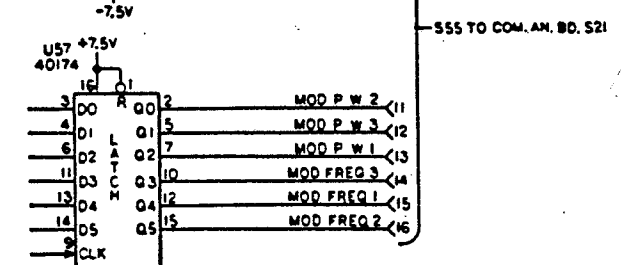
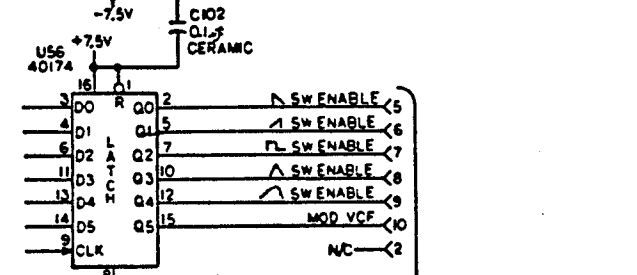
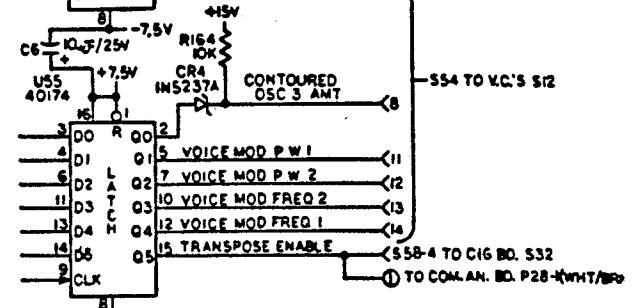
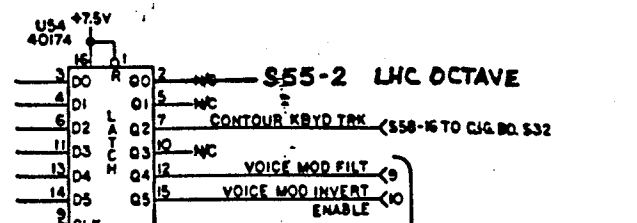
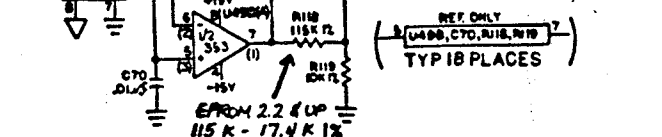
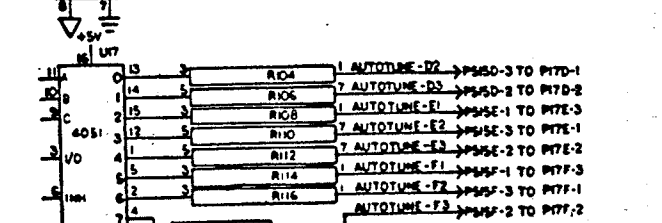
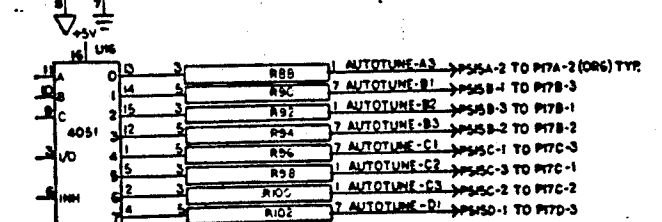
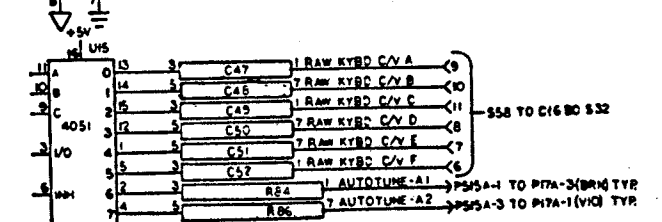
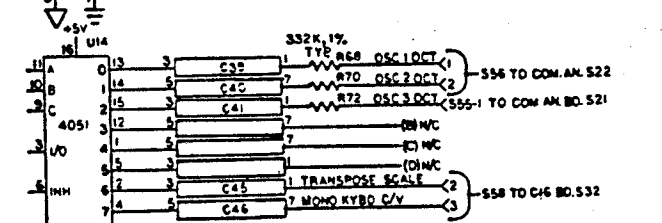
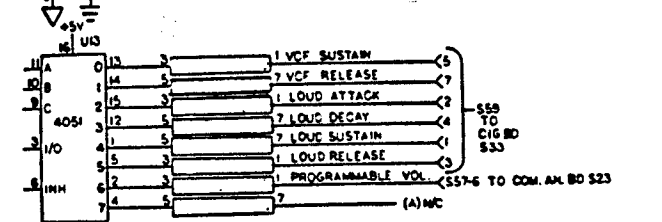
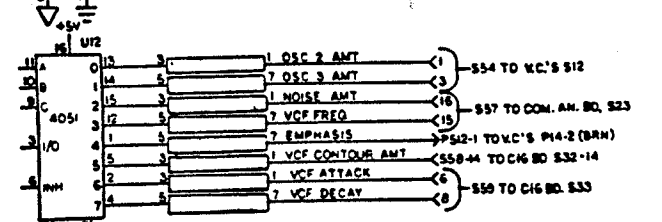
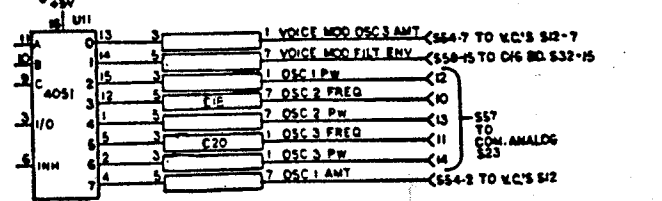
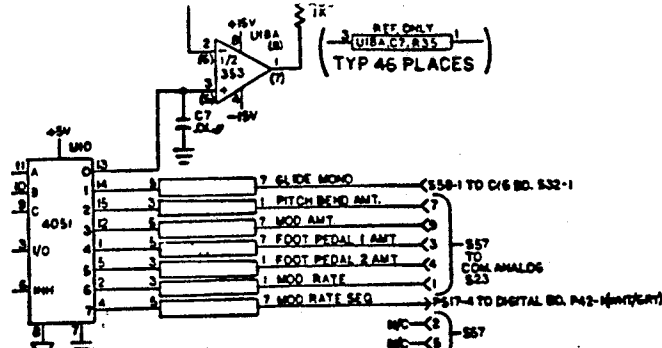

DMUX #5

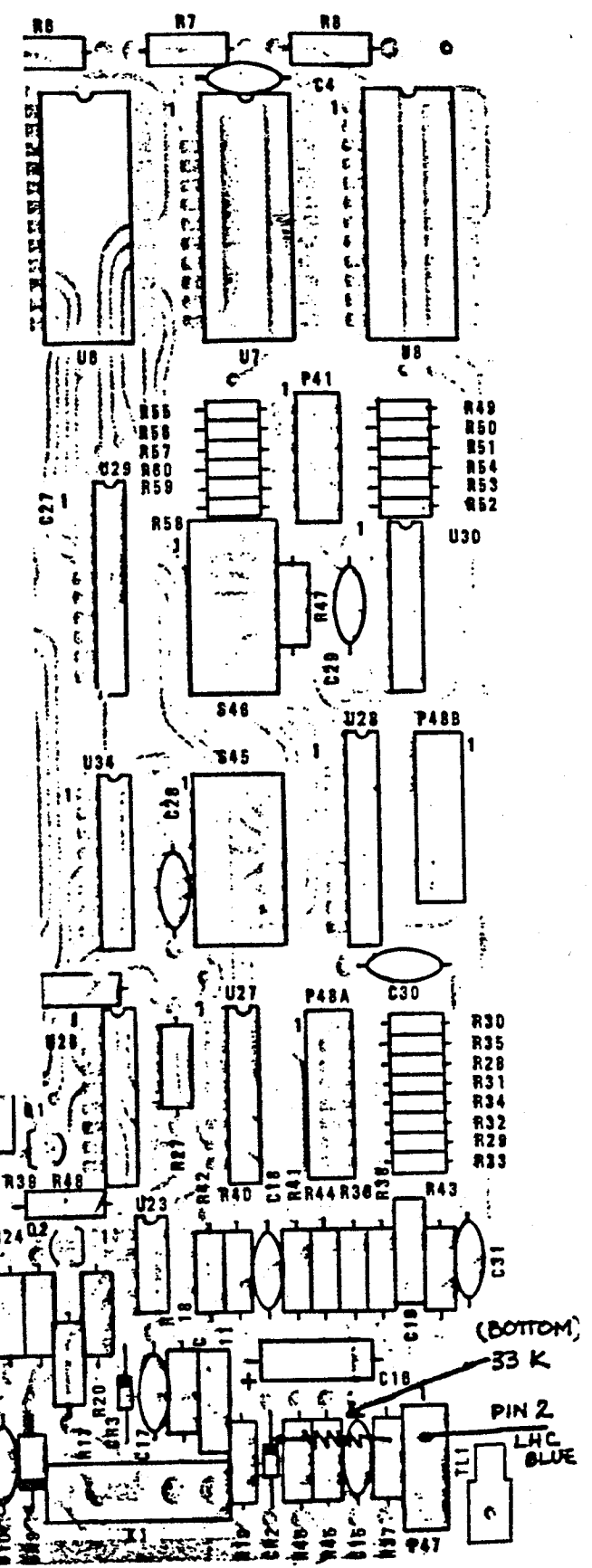
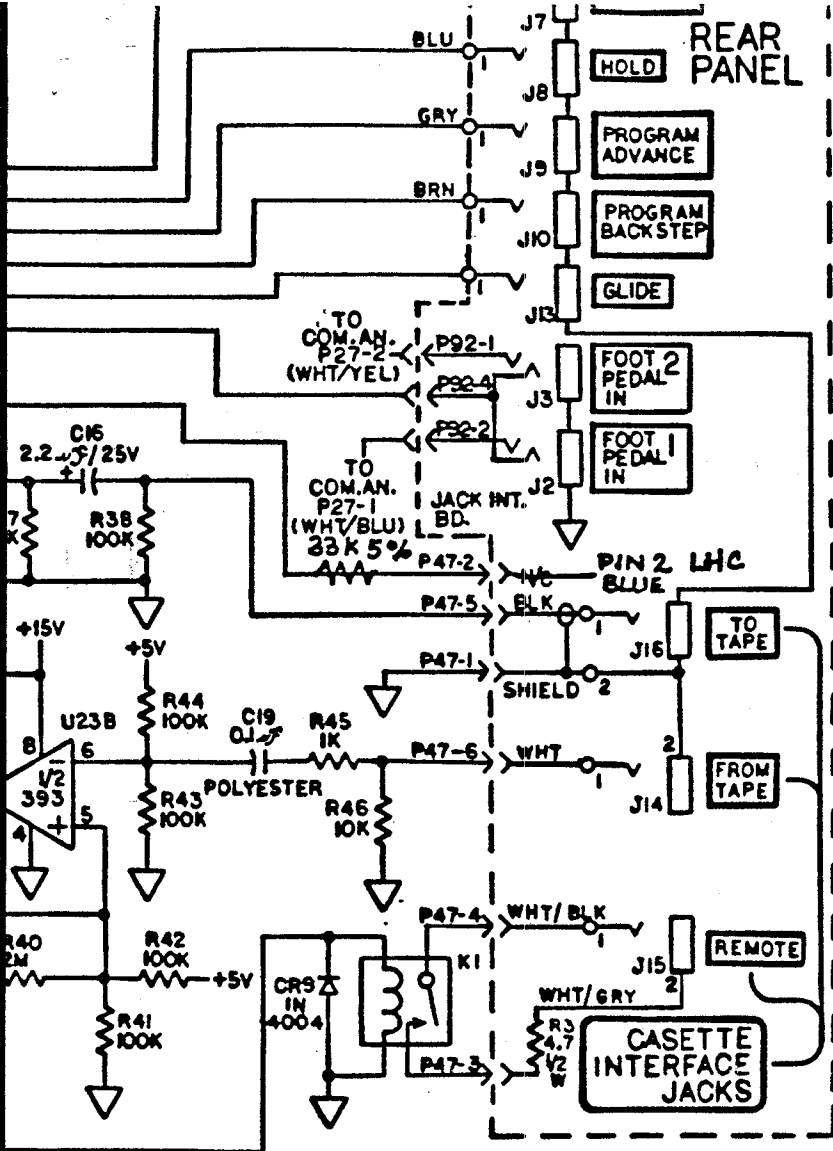

DIGITAL PRINTED CIRCUIT BOARD (BOARD NO. 4)

REVISED 3/83

DIGITAL
MEMORYMOOG 4

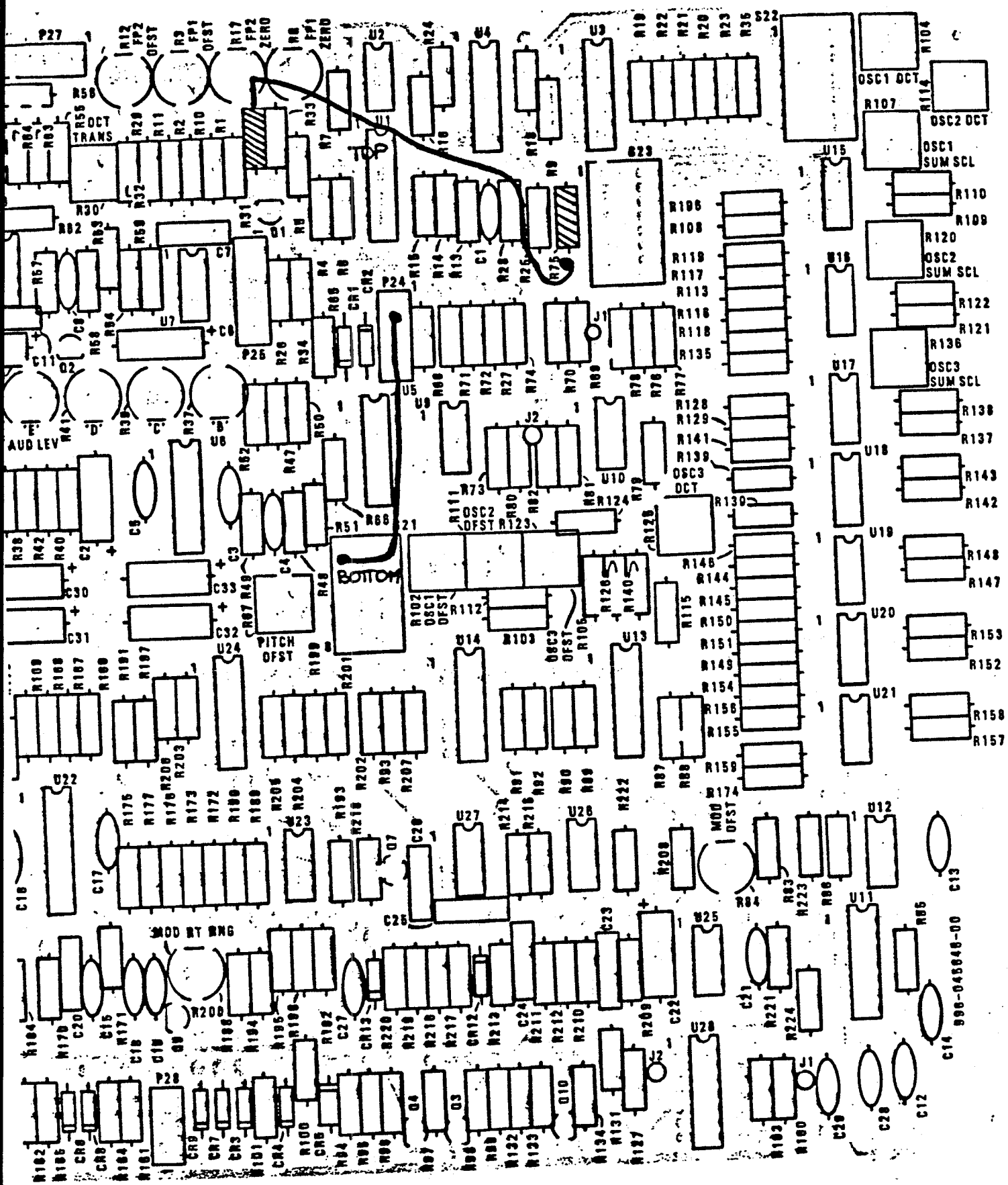

NON ANALOG PRINTED CIRCUIT BOARD (BOARD NO. 2)

REVISED 3/83

COMMON ANALOG
MEMORYMOOG 2

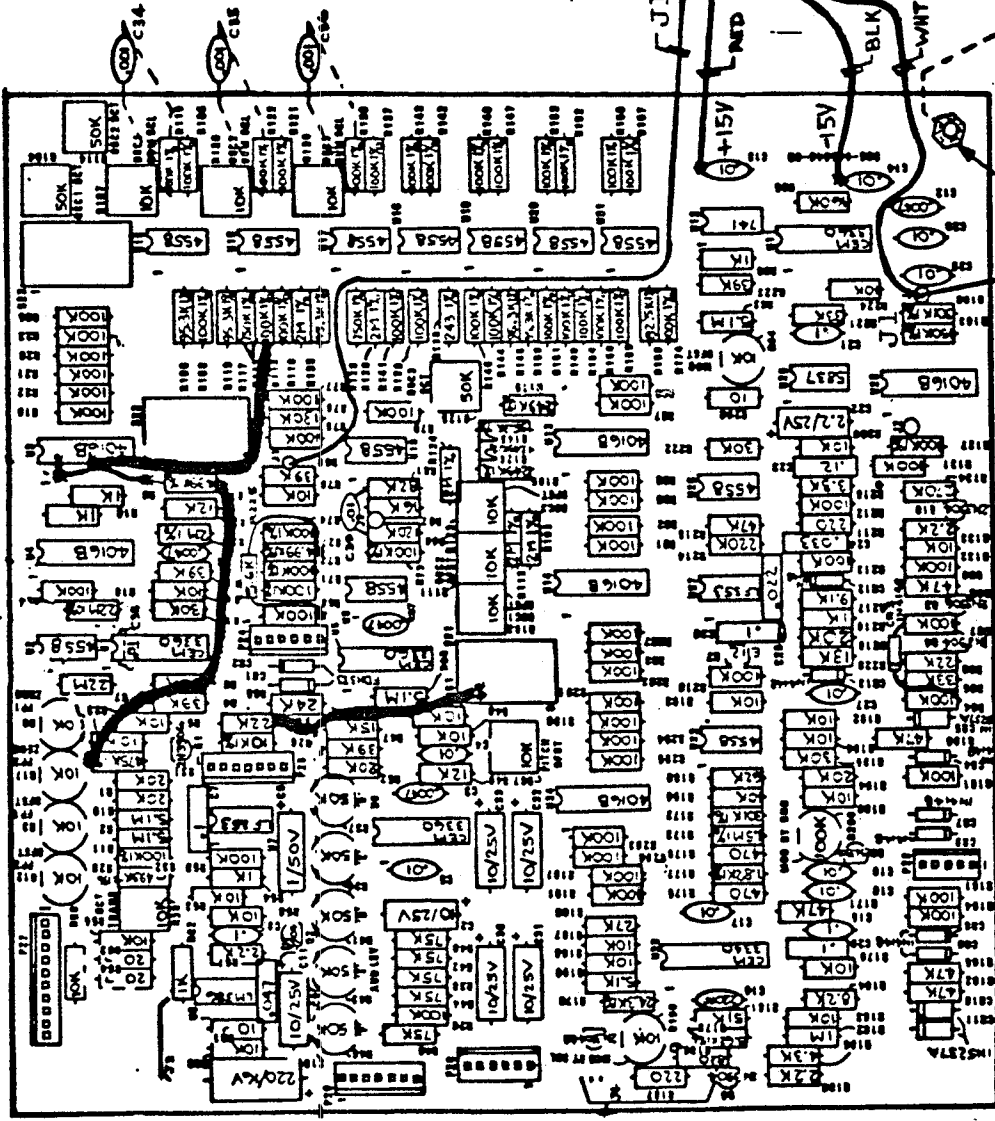

UNSOLDER J1 FROM FRONT EDGE OF C/A BOARD AND ATTACH HERE

TO OLD J1 HOLE ON FRONT EDGE OF C/A BOARD AND SOLDER +/-15 AS SHOWN

J1 REROUTED

BUFFER BOARD

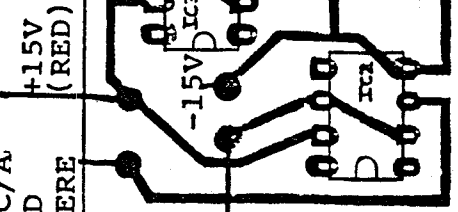

OLD J1 HOLE

4-40x3/8" SCR NO 4 EXT TOOTH LCK WASHER

STANDOFF THRU 4-40x3/8" SCR (FAR SIDE) NO 4 EXT TOOTH LCK WASHER (FAR SIDE)

