

YAMAHA

COMBO SYNTHESIZER

CS-15

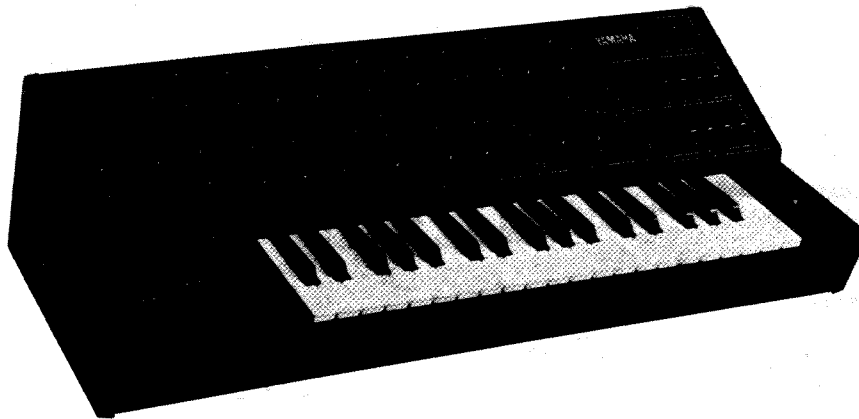

SERVICE MANUAL

CONTENTS

	Coding Guide	2
	Disassembly Procedure	3
	Specifications	4
	Panel Layout.....	5
SSK	Circuit Diagram.....	6
SSK	Circuit Board	7
CPA	Circuit Diagram.....	8
CPA	Circuit Board	9
CPB	Circuit Diagram.....	10
CPB	Circuit Board	11
PN1	Circuit Diagram & Circuit Board.....	12
REG	Circuit Diagram & Circuit Board	13
Key Switch	Circuit Diagram.....	14
REAR PANEL	Circuit Diagram & Circuit Board	15
	Electrical Checks & Adjustments	16
PARTS LIST	Exploded View	22
	Mechanical Parts	23
	Circuit Boards and Electrical Parts	25

CODING GUIDE

1 Wiring Notation

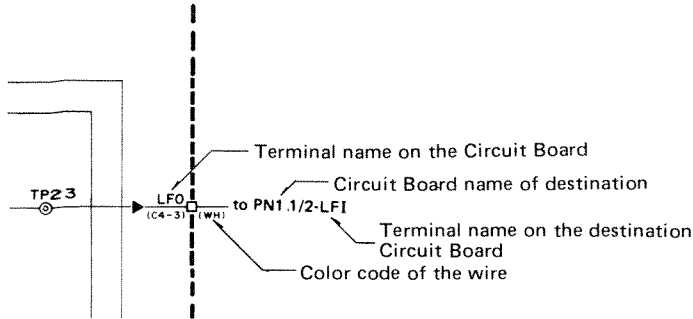

Note: Types of wire

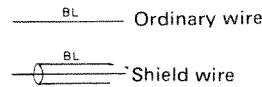

2 Symbol Description

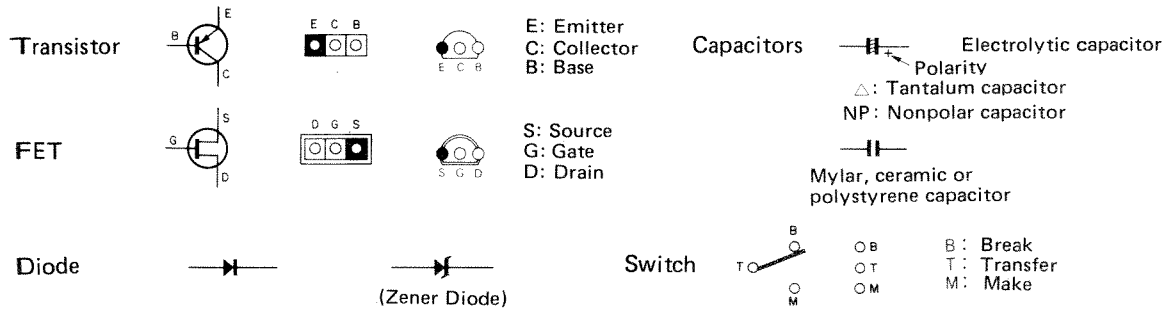

3 Abbreviations of Wire Color Codes

BLACK (クロ).....BL	BROWN (チャ).....BR	RED (アカ).....RE
ORANGE (ダイ).....OR	YELLOW (キイ).....YE	GREEN (ミド).....GR
BLUE (アオ).....BE	VIOLET (ムラ).....VI	GRAY (ハイ).....GY
WHITE (シロ).....WH	GRASS GREEN (クサ).....GG	SKY BLUE (ソラ).....SB
PINK (モモ).....PK	TRANSPARENT (トウメイ).....TR	

4 Relation of Color Coding and Notes

C	C≠	D	D≠	E	F	F≠	G	G≠	A	A≠	B
BR	RE	OR	YE	GR	BE	VI	GY	WH	GG	SB	PK
(チャ)	(アカ)	(ダイ)	(キイ)	(ミド)	(アオ)	(ムラ)	(ハイ)	(シロ)	(クサ)	(ソラ)	(モモ)

5 Logic Symbols

	MIL	YAMAHA
NOT		
NOR		
NAND		

Exclusive OR
(排他的論理和)

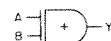

Truth Table

A	B	Y
L	L	L
H	L	H
L	H	H
H	H	L

NOT
(Inverter)



Truth Table

A	Y
L	H
H	L

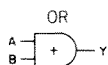

Truth Table

A	B	Y
L	L	L
H	L	H
L	H	H
H	H	H



Truth Table

A	B	Y
L	L	H
H	L	L
L	H	L
H	H	L

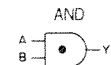

Truth Table

A	B	Y
L	L	L
H	L	L
L	H	L
H	H	H

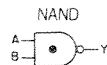

Truth Table

A	B	Y
L	L	H
H	L	H
L	H	H
H	H	L

DISASSEMBLY PROCEDURE

1. Panel

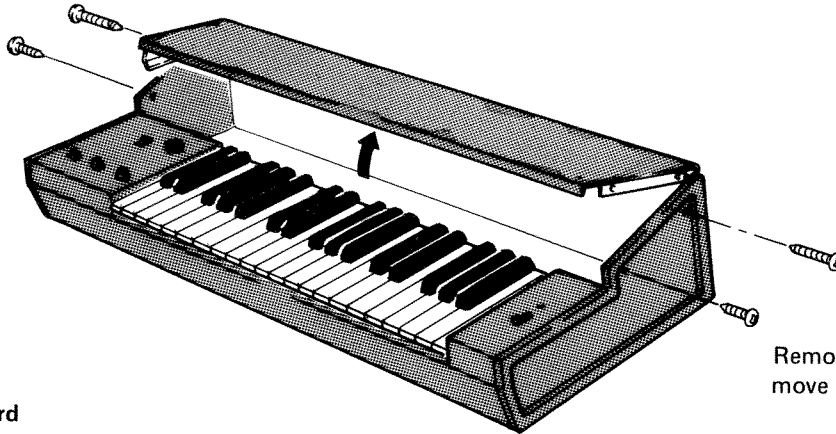

Remove the screws illustrated and move the panel up around.

2. Keyboard

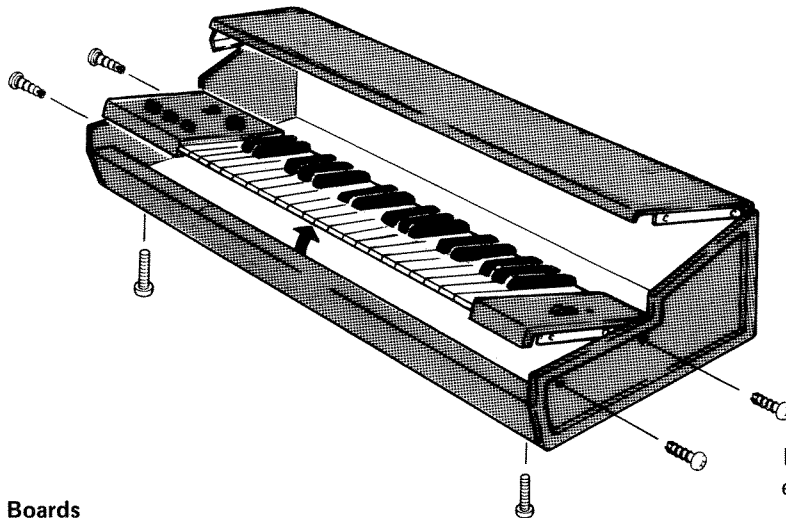

Remove the panel and screws illustrated. Then lift the keyboard around.

3. Circuit Boards

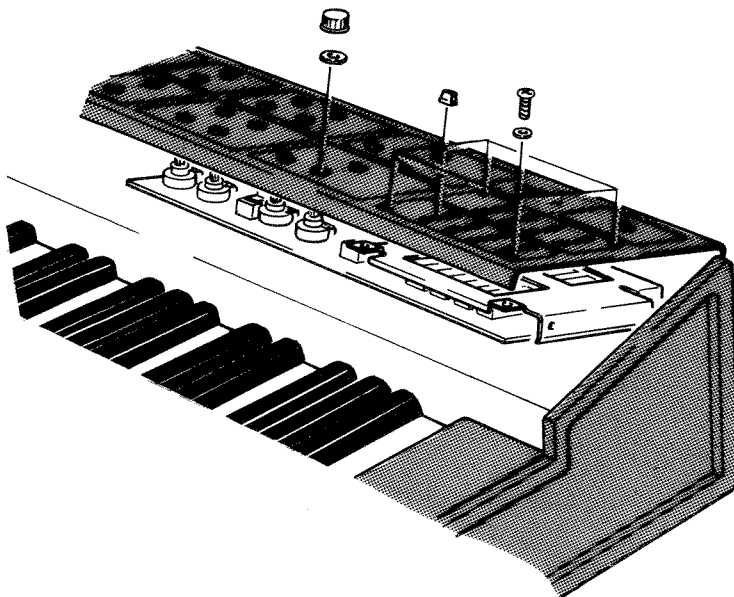

Remove the knob and hex nut of each control carefully so that the panel will not be damaged. (Remove the screws of EG for the CPB Circuit Board.) Then remove the Circuit Boards gently from the panel.

SPECIFICATIONS

KEYBOARD

37 keys, 3 octaves

CONTROLS

- EXTERNAL**TRIGGER LEVEL Control
EXT/NOISE Switch
- LFO**SPEED Control: 0.1 to 100Hz
Waveform Selector: \sim / \wedge / S/H
- PITCH**TUNE Control: -75 to +75 cents
VCO 2 DETUNE Control: -750 to +850 cents
- GLIDE**TIME Control: Max. 15 sec.
VCO 1 DEPTH: -750 to +550 cents
VCO 2 DEPTH: -750 to +550 cents
- VCO 1**FEET Switch: 64', 32', 16', 8', 4', 2'
WAVE Selector: \wedge / \wedge / \square
LFO MOD Control: -1,000 to +700 cents
PW Control: 50 to 90%
PWM Control: 35 to 80%
- VCO 2**FEET Switch: 64', 32', 16', 8', 4', 2'
WAVE Selector: \wedge / \wedge / \square
LFO MOD Control: -1,000 to +700 cents
PW Control: 50 to 90%
PWM Control: 35 to 80%
- MIXER 1**EXT/NOISE Control
VCO 1 Control
- MIXER 2**VCO 1 Control
VCO 2 Control
- VCF 1**CUT OFF FREQ Control
RESONANCE Control: Q = 0.5 to 10
LFO MOD Control: ± 3 octaves
EG DEPTH Control: Max. 10 octaves
Filter Selector: HPF/BPF/LPF
HPF 12 dB/oct.
BPF 6 dB/oct.
LPF 12 dB/oct.
EG Selector: EG 1+/EG 1-/EG 2+
- VCF 2**CUT OFF FREQ Control
RESONANCE Control: Q = 0.5 to 10
LFO MOD Control
EG DEPTH Control: Max. 10 octaves
Filter Selector: HPF/BPF/LPF
HPF 12 dB/oct.
BPF 6 dB/oct.
LPF 12 dB/oct.
EG Selector: EG 1+/EG 2+/EG 2-
- VCA 1**LFO MOD: AM modulation, max. 90%
INITIAL LEVEL Control
EG DEPTH Control
EG Selector: EG 1/EG2
- VCA 2**LFO MOD: AM modulation, max. 90%
INITIAL LEVEL Control
EG DEPTH Control
EG Selector: EG 1/EG 2

- EG 1**Trigger Selector: EXT/KBD
Time Switch: NORMAL/TIME x 5
ATTACK TIME: 0.0025 to 2.5 sec.
DECAY TIME: 0.005 to 6 sec.
SUSTAIN LEVEL: 0 to 10V
RELEASE TIME: 0.005 to 6 sec.
- EG 2**Time switch: NORMAL/TIME x 5
ATTACK TIME: 0.0025 to 2.5 sec.
DECAY TIME: 0.005 to 6 sec.
SUSTAIN LEVEL: 1 to 10V
RELEASE TIME: 0.005 to 6 sec.
- OUTPUT**VOLUME control
- PORTAMENTO**Max. 3.5 sec.
- BRILLIANCE**VCF Selector: 1/1 + 2/2
Control Lever: - to 0 to +
- PITCH BEND**Variable Range: N/M/W
N (Narrow) ± 200 cents
M (Middle) ± 300 cents
W (Wide) $\pm 1,200$ cents
Control Lever: -to 0 to +

REAR PANEL

- EXTERNAL IN**Input Sensitivity: 0/-20 dB
- TRIGGER**EG 1 IN, EG 2 IN
(OFF +15 to +3V) (ON 0 to -10V)
OUT (OFF +3V) (ON -7V)
- CONTROL VOLT**
.VCO 1 IN, VCO IN (+125mV to +4V)
OUT (+125mV to 4V)
- OUTPUT**HIGH Output level (2 dBm)
LOW Output level (-18 dBm)

FRONT PANEL

PHONES Jack

OTHERS

POWER SOURCE

-USA and Canadian models 120V 60Hz
General models
110, 130, 220 or 240V selectable,
50/60Hz

POWER CONSUMPTION

-15 watts

DIMENSIONS754 x 174 x 332.5 mm
(W x H x D) (29-5/8 x 6-7/8 x 13-1/8")

WEIGHT10 kg (22 lbs.)

FINISHSemi-gloss black

* Specifications subject to change without notice.

REG Circuit Diagram, Circuit Board

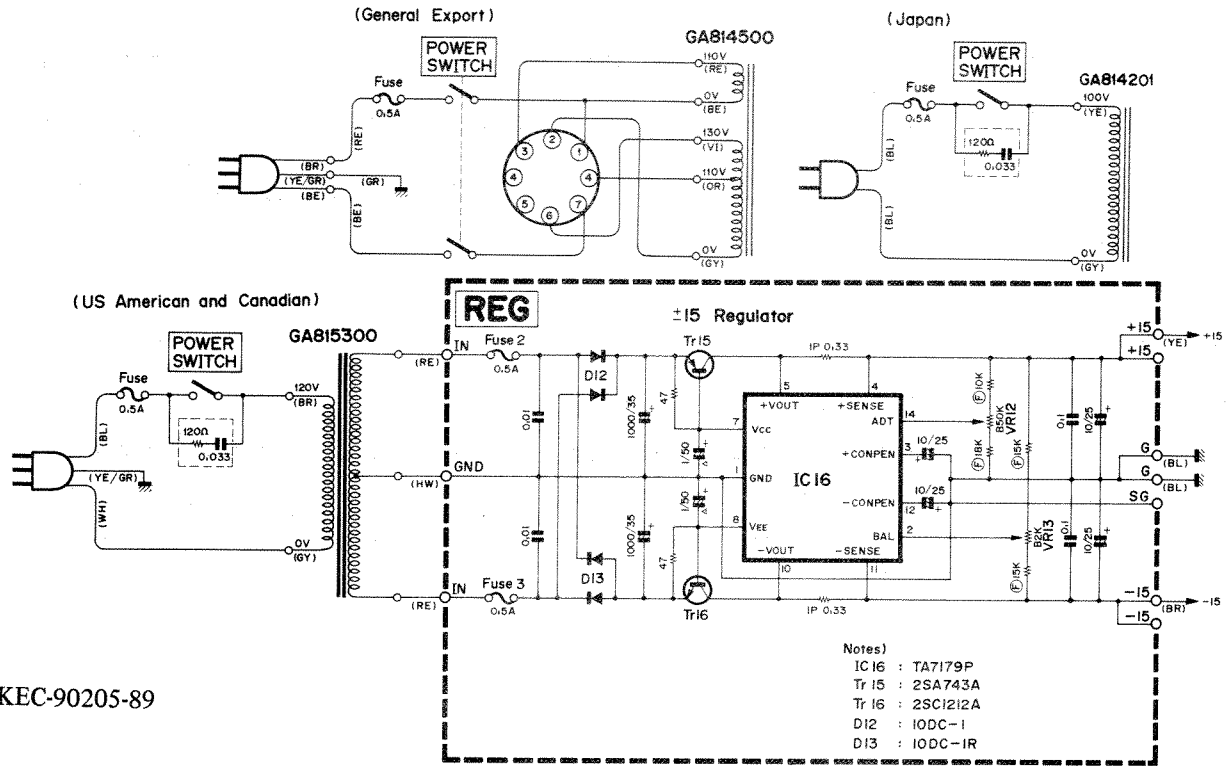

KEC-90205-89

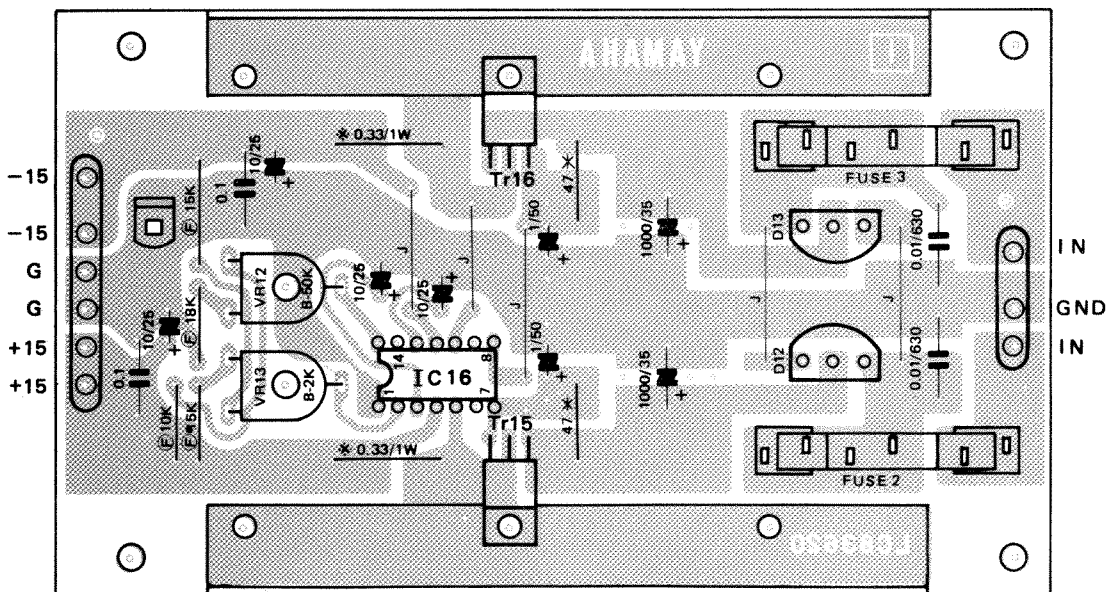

Note)

- | | |
|-----------------|--|
| 1. IC | 3. Diodes |
| IC16 : TA7179P | D12 : 10DC-1 |
| 2. Transistors | D13 : 10DC-1R |
| Tr15 : 2SA743A | 4. Resistors |
| Tr16 : 2SC1212A | Marked ⊕ : metal film |
| | Marked * : metal oxide (unflammable, 1W) |
| | Marked ✱ : carbon |

Key Switch Circuit Diagram

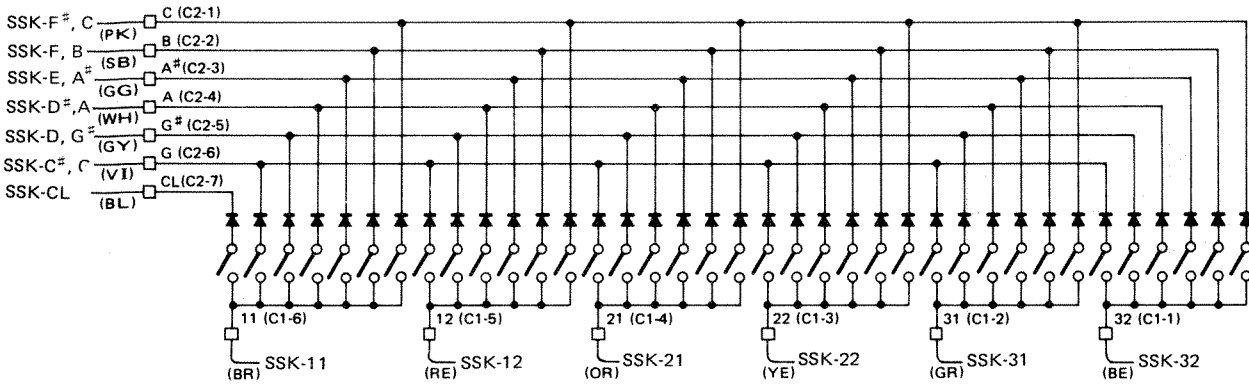
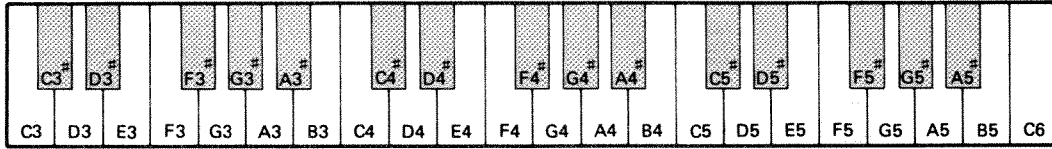

- Set the FUNCTION switch of the LFO block to S/H. The waveform given below should be at TP13.

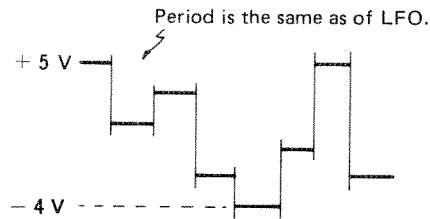

Fig. 5

4. Channel 1 VCO

- Adjust TUNE (PVR5) to read $0 \pm 0.1V$ at TP14.
- Set LFO MOD (PVR12) to 0, FEET selector (PSW10) to "2'", and the adjusting pot VR6 to the center position, and depress C6 key. Read $8,429 \pm 2Hz$ at TP22 by adjusting VR5 coarsely and VR6 finely. Then depressing C3 key, adjust VR4 to read $1,053 \pm 1Hz$. Repeat the steps until the specified frequency is read at TP22.
- Read the following values at each position of the FEET selector (PSW10) when key C6 key is depressed.

FEET	Frequency[Hz]
2'	8429
4'	4215
8'	2107
16'	1053.6
32'	526.8
64'	263.4

Tolerance 0.2%

- Next, set FEET (PSW10) to "8'", LFO SPEED (PVR3) to S, LFO FUNCTION (PSW4) to " \sim ", and LFO MOD (PVR12) to "10". When C6 key is depress, reading should vary from $1,180 \pm 150Hz$ to $3,100 \pm 200Hz$ at TP22 at the speed determined by LFO SPEED (PVR3). The frequency range is determined by LFO MOD (PVR12).

● **G LIDE**

- e) Set LFO MOD (PVR12) at "0", VCO 1 DEPTH (PVR8) at "+", and TIME (PVR7) at L. Leave key C6 turned on. Then, reading should vary to $2,860 \pm 100\text{Hz}$ and, in 15 ± 3 seconds, back to $2,107 \pm 20\text{Hz}$ at TP22. The width of variation is determined by VCO1 DEPTH (PVR8) and the interval by TIME (PVR7).
- f) Similarly, when VCO1 DEPTH (PVR8) is set at "-", reading should vary to $1,350 \pm 100\text{Hz}$ and, in 15 ± 3 seconds, back to $2,107 \pm 20\text{Hz}$ at TP22.

● **TUNE**

- g) Set VCO1 DEPTH (PVR8) at "0", and TUNE (PVR5) at "+". When C6 key is turned on, read $2,205 \pm 20\text{Hz}$ at TP22 and $2,010 \pm 20\text{Hz}$ when TUNE is reset to "-".

5. WAVE SHAPE CONVERTER

- a) In the current setting, reset TUNE (PVR5) to "0", WAVE (PSW11) to " \wedge ", VCO1 (PVR21) to "10", and EXT/NOISE (PVR20) to "0". Now see if the waveform given below is at TP23 when a key is turned on.

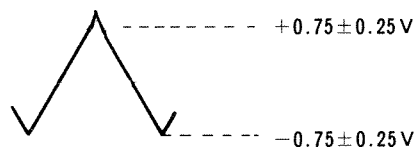

Fig. 6

- b) Detect the waveform given below when WAVE (PSW11) is set at " \nearrow ".

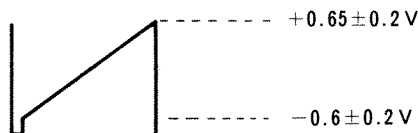

Fig. 7

- c) Set PWM (PVR14) at "0", WAVE (PSW11) at " \square ", and PW (PVR13) at "50%". Now detect the waveform given below.

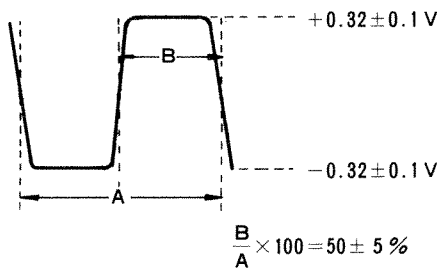

Fig. 8

- d) Set PSW (PVR14) at "10" and PW (PVR13) at "90%". Then adjust VR12 so that the signal rises to $95 \pm 3\%$ at point "a" in Fig. 9-A. Detect the waveform given in (B) when PWM (PVR14) is set at "0".

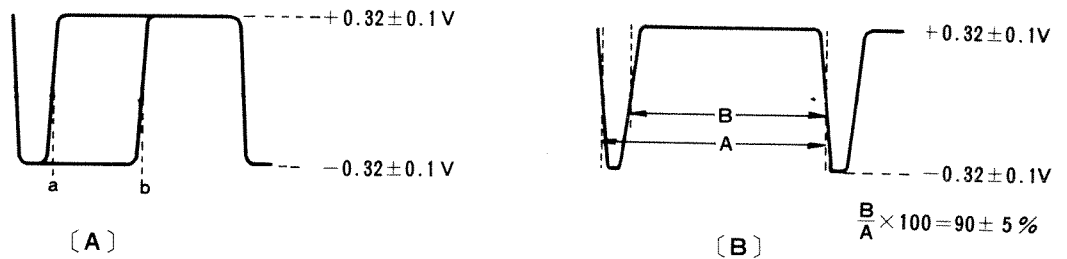

Fig. 9

6. DETUNE Circuit

- Connect a dummy plug to terminal CONTROL VOLT VCO2 IN on the rear panel. Adjust VR10 to read $0 \pm 50 \mu\text{V}$ at TP17 (KV4).
- Set VCO2 DETUNE (PVR6) at "0" position. Turning on key C6, adjust VR11 to read $2 \pm 0.001\text{V}$ at TP17 (KV4). Next, read $1.29 \pm 0.1\text{V}$ at TP17 (KV4) when VCO2 DETUNE (PVR6) is set at "-" and $3.30 \pm 0.2/-0.4\text{V}$ when it is set at "+".

7. Channel II

- Turning on C6 key, adjust VCO2 DETUNE (PVR6) to read $2 \pm 0.001\text{V}$ at TP17 (KV4).
- Then carry out the same adjustment as for channel I.

● CPB CIRCUIT BOARD

CHANNEL 1

1. VCF

Adjust CUTOFF FREQ (PVR24) to read $5 \pm 0.1V$ at TP8.
 Adjust RESONANCE (PVR25) to read $5 \pm 0.1V$ at TP9.
 Adjust BRILLIANCE (PVR58) to read $0 \pm 10mV$ at TP7.

VCF block	LFO MOD	Set to 0
	EG DEPTH	0
	HPF/BPF/LPF	LPF
VC block	FEET	2'
	WAVE	^
MIXER block	VCO 1	10

In the above setting, turn on C3 key and adjust MIXER so as to apply $1.0 \pm 0.05V_{p-p}$ to terminal IN (TP4).
 And compare the waveform given below to TP10 by adjusting the peak with VR1 and the peak level to $1.0 \pm 0.05V_{p-p}$ with VR2.

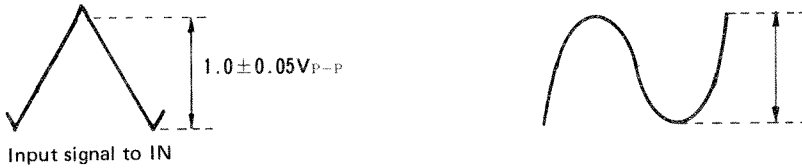

Fig. 10

2. VCA

Add the following conditions to the above setting.

VCF block	EG1+/EG1-/EG2+	EG1+
EG block	EXT/KBD	KBD
	NORMAL/TIME×5	NOMAL
	ATTACK TIME	S
	DECAY TIME	S
	SUSTAIN LEVEL	10
	RELEASE TIME	S
VCA block	INITIAL LEVEL	0
	LFO MOP	D
	EG DEPTH	10
	EG1/EG2	EG1

Turning on key C3, adjust VR4 to read $1.0 \pm 0.05V_{p-p}$ at TP11. Change the setting as given below.

LFO block	SPEED	F
	FUNCTION	~
VCA block	INITIAL LEVEL	10
	LFO MOD	10
MIXER block	EXT/NOISE	0
	VCO 1	0

Adjust VR3 to minimize the waveform at TP11.

3. Envelope Generator (EG-1)

	a	b
EXT/KBD(PSW44)	KBD	KBD
NOMMAL/TIME×5 (PSW35)	NORMAL	NORMAL
ATTACK TIME(PVR46)	L	S
DECAY TIME(PVR47)	L	S
SUSTAIN LEVEL(PVR48)	0	10
RELEASE TIME (PVR49)	0	L

a) Turn on a key in the above setting, compare the waveforms given below to TP22 and TP23.

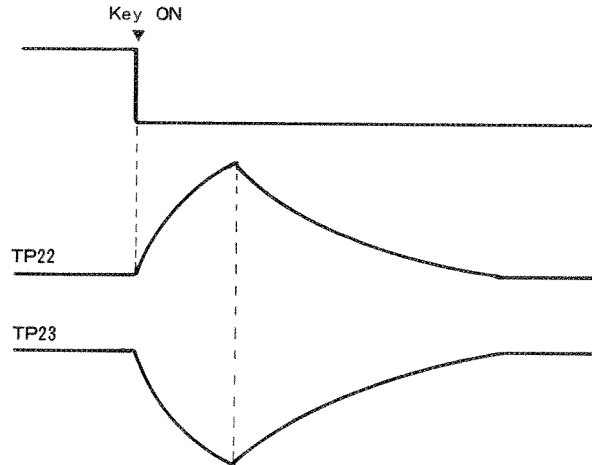

Fig. 11

b) Compare the waveform given below to TP22 when a key is turned on and off in the same conditions.

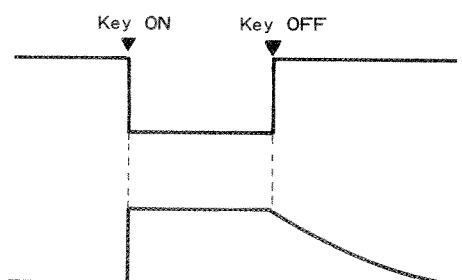
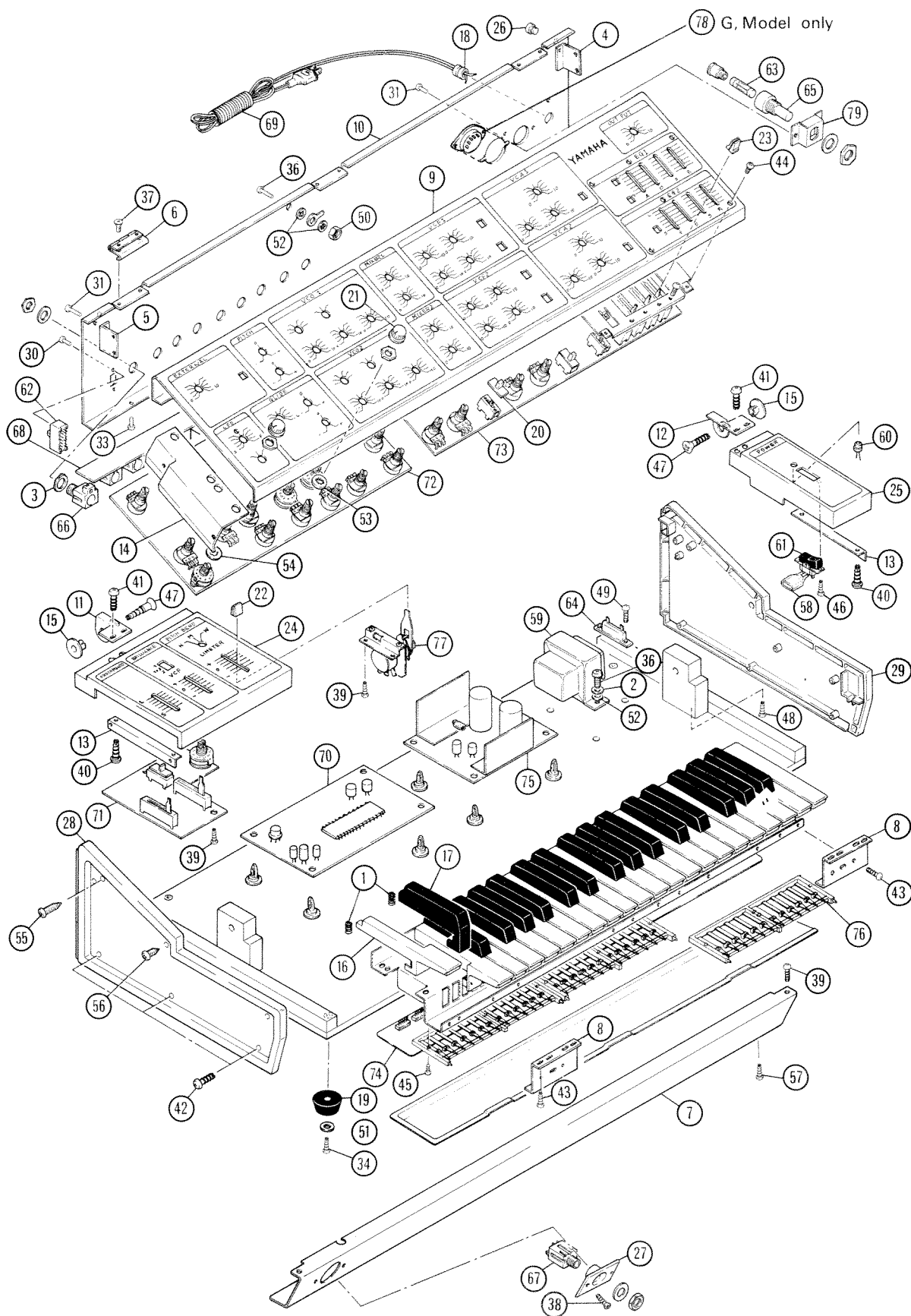

Fig. 12

PARTS LIST Exploded View



Mechanical Parts

J Japan U U.S.A C Canadian G General (Except J-U-C)

Ref. No.	Part No.	Description (部 品 名)	Remarks	Common Model
1	30 10 00 AA 04 37 20	Coil Spring	コイルスプリング	
2	30 54 00 AA 80 44 90	Flat Washer	平 座 金	
3	30 10 00 AA 80 58 20	Spacer	ス ペ ー サ ー	
4	30 10 00 AA 80 59 90	Angle	ア ン グ ル	
5	30 10 00 AA 80 72 10	"	"	
6	30 10 00 AA 80 72 60	Hinge	蝶 番	
7	30 10 00 AA 80 85 60	Front rail	口 板	
8	30 10 00 AA 80 85 90	Front rail Spacer	口 金	
9	30 10 00 AA 80 86 10	Control Panel	コントロールパネル	
10	30 10 00 AA 80 86 20	Rear Panel	リ ア パ ネ ル	J
	30 10 00 AA 80 86 30	"	"	U, C
	30 10 00 AA 80 98 20	"	"	G
11	30 10 00 AA 80 87 10	End Block Angle (L)	回 転 金 具 (左)	
12	30 10 00 AA 80 87 20	" (R)	" (右)	
13	30 10 00 AA 80 87 40	End Block Holder	拍 子 木 金 具	
14	30 10 00 AA 80 90 20	Panel Holder	パ ネ ル 取 付 金 具	
15	30 10 00 CB 01 18 30	Bushing	ブ ッ シ ュ	
16	30 10 00 CB 03 22 10	White Key	白 鍵	C, F
	30 10 00 CB 03 22 20	"	"	D
	30 10 00 CB 03 22 30	"	"	B, E
	30 10 00 CB 03 22 40	"	"	G
	30 10 00 CB 03 22 50	"	"	A
	30 10 00 CB 03 22 60	"	"	C'
17	30 10 00 CB 03 22 70	Black Key	黒 鍵	
18	30 10 00 CB 07 27 50	Cord Bushing	コ ー ド ブ ッ シ ュ	J
	30 10 00 CB 81 12 30	"	"	U, C
	30 10 00 CB 03 28 40	"	"	G
19	30 10 00 CB 80 12 70	Leg	ゴ ム 脚	
20	30 10 00 CB 80 52 30	Knob	ツ マ ミ	
21	30 10 00 CB 81 01 30	"	"	
22	30 10 00 CB 81 12 80	"	"	
23	30 10 00 CB 81 12 90	"	"	
24	30 10 00 CB 81 26 80	End Block (Left)	拍 子 木 (左)	
25	30 10 00 CB 81 26 90	" (Right)	" (右)	
26	30 10 00 CB 81 28 20	Stopper Rubber	ス ト ッ パ ー ゴ ム	
27	30 10 00 CB 81 28 40	Phone Panel	フ ォ ー ン パ ネ ル	
28	30 10 00 CB 81 29 30	Side Board (Left)	側 板 (左)	
29	30 10 00 CB 81 29 40	" (Right)	" (右)	
30	40 10 00 EA 32 60 40	Pan Head Screw	M2.6 x 4 ZMC2-BI	ナ ベ 小 ネ ジ
31	40 10 00 EA 33 00 60	"	M3 x 6	"
33	40 10 00 EA 33 01 00	"	M3 x 10 "	"
34	40 10 00 EA 33 01 40	"	M3 x 14 "	"
36	40 10 00 EA 34 01 00	"	M4 x 10 "	"
37	40 10 00 EB 03 00 50	Flat Head Screw	M3 x 5 ZMC2-Y	サ ラ 小 ネ ジ
38	40 10 00 EF 33 00 80	Oval Head Screw	M3 x 8 ZMC2-BI	丸 皿 小 ネ ジ
39	40 10 00 E i 03 00 80	Self Tapping Screw	3 x 8 ZMC2-Y	バ イ ン ド タ ッ ピ ン グ ネ ジ
40	40 10 00 E i 04 00 80	"	4 x 8 "	"
41	40 10 00 E i 04 01 00	"	4 x 10 "	"
42	40 10 00 E i 34 02 50	"	4 x 25 ZMC2-BI	"
43	40 10 00 EJ 04 00 80	Pan Head Tapping Screw	4 x 8 ZMC2-Y	ナ ベ タ ッ ピ ン グ ネ ジ
44	40 10 00 EL 33 00 50	Truss Head Screw	M3 x 6 ZMC2-BI	ト ラ ス 小 ネ ジ
45	40 10 00 EO 02 00 80	Flat Head Tapping Screw	2 x 8 ZMC2-Y	サ ラ タ ッ ピ ン グ ネ ジ
46	40 10 00 EO 03 00 80	"	3 x 8 "	"

* New Parts

Ref. No.	Part No.	Description (部 品 名)	Remarks	Common Model
47	40 10 00 EP 04 12 50	Flat Head Wood Screw 4.1 x 25 ZMC2-Y	サ ラ 木 ネ ジ	
48	40 10 00 EP 33 52 50	" 3.5 x 25 ZMC2-BI	"	
49	40 10 00 EQ 03 11 00	Round Head Wood Screw 3.1 x 10 ZMC2-Y	丸 木 ネ ジ	
50	40 10 00 EV 10 00 40	Hexagonal Nut 4 φ "	六 角 ナ ッ ト	
51	40 10 00 EV 20 30 40	Flat Washer 4 φ ZMC2-BI	平 座 金	
52	40 10 00 EV 43 00 40	Toothed Lock Washer 4 φ ZMC2-Y	歯 付 座 金	
53	40 10 00 EV 43 00 70	" 7 φ "	"	
54	40 10 00 EV 43 00 90	" 9 φ "	"	
55	40 10 00 EZ 98 06 00	Binding Screw M4 x 18 ZMC2-BI	尖 先 バ イ ン ド 小 ネ ジ	
56	40 10 00 EZ 98 06 10	" M4 x 10 "	"	
57	40 10 00 EZ 98 06 20	" M5 x 20 "	"	
58	40 10 00 FZ 00 01 10	Spark Killer	ス パ ー ク キ ラ ー	J, U
	40 10 00 FZ 00 09 50	"	"	C
※	59 30 10 00 NB 81 12 80	Power Transformer Unit	電 源 ト ラ ン ス ユ ニ ッ ト	J
	30 10 00 NB 81 28 10	"	"	U, C
	30 10 00 NB 81 28 20	"	"	G
	40 10 00 GA 81 42 10	Power Transformer	電 源 ト ラ ン ス	J
	40 10 00 GA 81 53 00	"	"	U, C
	40 10 00 GA 81 45 00	"	"	G
	40 10 00 LB 60 17 90	Connector 3P	コ ネ ク タ ー	
	40 10 00 LB 60 13 90	Connector Terminal	コ ネ ク タ ー タ ー ミ ナ ル	
	40 10 00 LB 60 15 50	Connector	コ ネ ク タ ー	G
	40 10 00 LB 60 16 70	Pin Contact	ピ ン コ ン タ ク ト	G
60	40 10 00 i F 00 13 10	L E D TLR-102KB	L E D	
61	40 10 00 KA 10 09 30	Power Switch SJ1923	パ ワ ー ス イ ッ チ	J
※	40 10 00 KA 10 09 80	"	"	U, C
※	40 10 00 KA 10 09 90	"	"	G
62	40 10 00 KA 40 02 50	Slide Switch	ス ラ イ ド ス イ ッ チ	
63	40 10 00 KB 00 03 10	Fuse 250V 0.5A	ヒ ュ ー ズ	J, U, C
	40 10 00 KB 00 07 10	" 500mAT	"	G
※	64 40 10 00 LA 00 29 50	2P Terminal	2 P 端 子 板	J, U, C
	40 10 00 LA 00 10 00	3P "	3 P "	G
65	40 10 00 LB 20 04 90	Fuse Holder SN2052	ヒ ュ ー ズ ホ ル ダ ー	J, U, C
	40 10 00 LB 20 05 90	"	"	G
66	40 10 00 LB 20 08 60	Jack	ジ ャ ッ ク	
67	40 10 00 LB 40 01 00	"	"	
※	68 40 10 00 LC 83 70 00	JK P. C Board	JK シ ー ト プ リ ン ト 基 板	
69	40 10 00 MG 00 04 10	AC Cord Assembly	電 源 コ ー ド	J
	40 10 00 MG 00 02 70	"	"	U, C
	40 10 00 MG 00 04 50	"	"	G
※	70 30 12 45 NA 80 43 20	SSK Circuit Board ⇨ P. 26 ~ 27	S S K シ ー ト	
※	71 30 12 00 NA 80 43 30	PN1 Circuit Board	P N 1 シ ー ト	
※	72 30 12 45 NA 80 43 40	CPA Circuit Board	C P A シ ー ト	
※	73 30 12 45 NA 80 43 50	CPB Circuit Board	C P B シ ー ト	
74	30 10 00 NA 80 43 90	MK Circuit Board	M K シ ー ト	
75	30 12 00 NA 80 44 30	REG Circuit Board	R E G シ ー ト	J
76	30 10 00 NB 05 51 50	Switch Assembly 13 Key	ス イ ッ チ Ass'y	
	30 10 00 NB 81 12 90	" 12 Key	"	
※	77 30 12 00 NB 81 12 90	Pitch Bend Assembly	ピ ッ チ ベ ン ド Ass'y	
78	40 10 00 LB 20 02 50	Voltage Selector	電 圧 切 替 器	G
	40 10 00 AA 80 64 40	Fuse Holder Bracket	平 座 金	

※ New Parts

Circuit Boards and Electrical Parts

Ref. No.	Part No.	Description (部 品 名)	Remarks	Common Model
※	30 12 45 NA 80 43 20	SSK Circuit Board	S S K シ ー ト	
※	40 10 00 HU 59 51 00	Metal Film Resistor 100Ω 0.1%	金 皮 抵 抗	
※	40 10 00 HU 59 61 00	" 1KΩ "	"	
※	40 10 00 HU 59 62 00	" 2KΩ "	"	
※	40 10 00 HZ 00 11 40	" 29.94KΩ "	"	
※	40 10 00 HZ 00 11 50	" 1.684KΩ "	"	
	40 10 00 HT 19 00 50	Variable Resistor B10KΩ	半 固 定 ボ リ ュ ー ム	
	40 10 00 iA 10 15 70	Transistor 2SA1015	ト ラ ン ジ ス タ	
	40 10 00 iA 18 15 10	" 2SC1815	"	
	40 10 00 iG 00 17 20	I C TC4069	I C	
	40 10 00 iG 02 55 00	" TA7504	"	
	40 10 00 iG 02 56 00	" TA7505	"	
	40 10 00 iG 02 84 00	" NJM4558	"	
	30 10 00 YM 24 80 00	" YM24800	"	
	40 10 00 LB 40 05 70	Connector 4P	コ ネ ク タ ー	
	40 10 00 LB 60 24 60	" 7P	"	
	40 10 00 LB 60 24 70	" 10P	"	
	40 10 00 LB 60 29 40	" 6P	"	
※	32 12 00 NA 80 43 30	PN1 Circuit Board	P N 1 シ ー ト	
※	40 10 00 HU 59 45 00	Metal Film Resistor 50Ω 0.1%	金 皮 抵 抗	
※	40 10 00 HU 59 55 00	" 500Ω "	"	
※	40 10 00 HU 59 65 50	" 5.5KΩ "	"	
※	40 10 00 HZ 00 10 70	" 66.7Ω "	"	
※	40 10 00 HZ 00 10 80	" 109.1Ω "	"	
※	40 10 00 HZ 00 10 90	" 122.5Ω "	"	
※	40 10 00 HZ 00 11 00	" 340.9Ω "	"	
※	40 10 00 HZ 00 11 20	" 810.8Ω "	"	
	40 10 00 HQ 42 00 30	Slide Variable Resistor B10KΩ	ス ラ イ ド ボ リ ュ ー ム	
	40 10 00 HQ 42 00 40	" A2MΩ	"	
	40 10 00 KA 40 03 60	Slide SW	ス ラ イ ド S W (2 回 路 3 接 点)	
※	40 10 00 KA 50 14 30	Rotary SW	ロ ー タ リ ー S W (4 回 路 3 接 点)	
	40 10 00 LB 40 06 30	Connector 4P	コ ネ ク タ ー	
	40 10 00 LB 60 30 00	" 7P	"	
	40 10 00 LB 60 30 10	" 8P	"	
※	30 12 45 NA 80 43 40	CPA Circuit Board	C P A シ ー ト	
	40 10 00 FM 09 71 00	BP Capacitor 10μF/16V	B P コ ン	
	40 10 00 FM 22 61 00	" 1μF/25V	"	
	40 10 00 FP 34 61 50	Tantalum Capacitor 1.5μF/25V	タ ン タ ル コ ン	
	40 10 00 FP 35 56 80	" 0.68μF/35V	"	
※	40 10 00 HU 59 65 00	Metal Film Resistor 5KΩ 0.1%	金 皮 抵 抗	
※	40 10 00 HU 59 71 00	" 10KΩ "	"	
※	40 10 00 HU 59 72 00	" 20KΩ "	"	
※	40 10 00 HU 59 74 00	" 40KΩ "	"	
※	40 10 00 HU 59 78 00	" 80KΩ "	"	
	40 10 00 HU 57 58 20	" 820Ω 1%	"	
	40 10 00 HU 57 61 60	" 1.6KΩ "	"	
	40 10 00 HU 57 65 10	" 5.1KΩ "	"	
	40 10 00 HU 57 68 20	" 8.2KΩ "	"	
	40 10 00 HU 57 71 00	" 10KΩ "	"	

* New Parts

Ref. No.	Part No.	Description (部 品 名)	Remarks	Common Model
	40:10:00:HU:57:71:10	Metal Film Resistor 11KΩ 1%	金 皮 抵 抗	
	40:10:00:HU:57:71:80	" 18KΩ "	" "	
	40:10:00:HU:57:72:00	" 20KΩ "	" "	
	40:10:00:HU:57:78:20	" 82KΩ "	" "	
	40:10:00:HU:57:81:00	" 100KΩ "	" "	
	40:10:00:HU:57:82:00	" 200KΩ "	" "	
	40:10:00:HU:57:82:70	" 270KΩ "	" "	
	40:10:00:iA:10:15:70	Transistor 2SA1015	ト ラ ン ジ ス タ	
	40:10:00:iE:00:00:10	F E T 2SK30A	F E T	
	40:10:00:iE:10:12:10	" 2SK105	"	
	40:10:00:iF:00:00:40	Diode 1S1555	ダ イ オ ー ド	
	40:10:00:iF:00:03:00	" 1S1715P	"	
	40:10:00:iG:00:15:00	I C #00150	I C	
	40:10:00:iG:00:15:30	" #00153	"	
	40:10:00:iG:02:55:00	" TA7504S	"	
	40:10:00:iG:02:84:00	" NJM4558	"	
	40:10:00:HS:31:05:50	Variable Resistor A10KΩ	ボ リ ュ ー ム	
	40:10:00:HS:31:05:70	" B10KΩ	"	
	40:10:00:HS:31:06:00	" A2MΩ	"	
※	40:10:00:HS:31:07:30	" B10KΩ	(センタークリック付)	
	40:10:00:HT:19:00:40	" B5KΩ	半固定ボリューム	
	40:10:00:HT:19:00:50	" B10KΩ	"	
	40:10:00:HT:19:00:70	" B50KΩ	"	
	40:10:00:HT:19:00:80	" B100KΩ	"	
	40:10:00:HT:19:01:00	" B500KΩ	"	
	40:10:00:HT:19:01:30	" B2KΩ	"	
	40:10:00:HT:19:01:40	" B200Ω	"	
	40:10:00:KA:40:06:00	Slide SW	ス ラ イ ド S W (2回路2接点)	
	40:10:00:KA:50:10:80	Rotary SW	ロ ー タ リ ー S W (2回路6接点)	
※	40:10:00:KA:50:14:30	" "	(4回路3接点)	
	40:10:00:LB:30:09:60	Connector 3P	コ ネ ク タ ー	
	40:10:00:LB:60:29:90	" 6P	"	
	40:10:00:LB:60:30:10	" 8P	"	
※	30:12:45:NA:80:43:50	CPB Circuit Board	C P B シ ー ト	
※	30:10:00:AA:80:86:50	EG Sub Panel	E G サ ブ パ ネ ル	
	40:10:00:FM:09:71:00	BP Capacitor 10μF/16V	B P コ ン	
	40:10:00:FM:11:61:00	" 1μF/50V	"	
	40:10:00:FP:33:64:70	Tantalum Capacitor 4.7μF/16V	タ ン タ ル コ ン	
	40:10:00:FP:34:61:00	" 1μF/25V	"	
	40:10:00:HL:31:24:70	Metal Film Resistor 0.47Ω 1P	金 皮 抵 抗	
	40:10:00:HL:32:36:80	" 6.8Ω 2P	"	
	40:10:00:HL:32:51:50	" 150Ω 2P	"	
	40:10:00:HQ:42:00:30	Slide Variable Resistor 810KΩ	ス ラ イ ド ボ リ ュ ー ム	
	40:10:00:HQ:42:00:40	" A2MΩ	"	
	40:10:00:HS:31:05:50	Variable Resistor A10KΩ	ボ リ ュ ー ム	
	40:10:00:HS:31:05:70	" B10KΩ	"	
	40:10:00:HT:19:00:70	" B50KΩ	半固定ボリューム	
	40:10:00:HT:19:00:80	" B100KΩ	"	
	40:10:00:HT:19:00:90	" B200KΩ	"	
	40:10:00:iA:05:09:10	Transistor 2SA509	ト ラ ン ジ ス タ	
	40:10:00:iA:10:15:20	" 2SA1015	"	

※ New Parts

Ref. No.	Part No.	Description (部品名)	Remarks	Common Model
	40 10 00 iC 05 09 20	Transistor 2SC509	トランジスタ	
	40 10 00 iC 18 15 10	" 2SC1815	"	
	40 10 00 iF 00 00 10	F E T 2SK30A	F E T	
	40 10 00 iF 00 00 40	Diode 1S1555	ダイオード	
	40 10 00 iG 00 15 10	I C iG00151	I C	
	40 10 00 iG 00 15 60	" iG00156	"	
	40 10 00 iG 02 84 00	" NJM4558	"	
	40 10 00 KA 40 05 90	Slide Switch	スライドスイッチ	
	40 10 00 KA 40 06 00	"	"	
	40 10 00 LB 30 09 60	Connector 3P	コネクタ	
	40 10 00 LB 50 03 70	" 5P	"	
	40 10 00 LB 60 30 10	" 8P	"	
*	40 10 00 LC 83 70 10	JK P. C Board	JKシートプリント基板	
	40 10 00 LB 20 08 60	Jack	ジャック	
	30 12 00 NA 80 44 30	REG Circuit Board #83622	R E G シート	J
	30 12 00 NA 80 52 30	"	"	U,C
	30 12 00 NA 80 52 40	"	"	G
	30 10 00 BA 80 34 90	Radiator	放熱板	
	40 10 00 HL 31 23 30	Metal Oxide Film Resistor 0.33Ω 1P	酸金抵抗	
	40 10 00 HT 19 00 70	Variable Resistor B50KΩ	半固定ボリューム	
	40 10 00 HT 19 01 30	" B2KΩ	"	
	40 10 00 HU 57 71 10	Metal Film Resistor 10KΩ 1%	金皮抵抗	
	40 10 00 HU 57 71 50	" 15KΩ "	"	
	40 10 00 HU 57 71 80	" 18KΩ "	"	
	40 10 00 iA 07 43 90	Transistor 2SA743	トランジスタ	
	40 10 00 iC 12 12 90	" 2SC1212	"	
	40 10 00 iG 03 20 10	I C TA7179	I C	
	40 10 00 iH 00 01 40	Diode 10DC-4	ダイオード	
	40 10 00 iH 00 01 50	" 10DC-4R	"	
	40 10 00 KB 00 02 00	Fuse 125V, 0.5A	ヒューズ	J
	40 10 00 KB 00 11 50	" 250V 0.5A	"	U,C
	40 10 00 KB 00 07 10	" 250V 500mA T	"	G
	40 10 00 LB 20 05 70	Fuse Holder	ヒューズホルダーピン	
	40 10 00 LB 60 13 80	Connector 6P	コネクタ	
	40 10 00 LB 60 18 00	" 3P	"	
	30 10 00 NA 80 43 90	MK Circuit Board #83710	M K シート	
	40 10 00 iF 00 00 40	Diode 1N1555	ダイオード	
	40 10 00 LB 60 24 60	Connector Base Pin 7P	トップ型ベースポスト	
	40 10 00 LB 60 29 40	" 6P	"	
	40 10 00 BB 00 44 30	Connector Contact	コンタクト	
	40 10 00 LB 30 07 20	Connector Housing 3P	ハウジング	
	40 10 00 LB 40 05 60	" 4P	"	
	40 10 00 LB 50 02 40	" 5P	"	
	40 10 00 LB 60 13 90	Connector Terminal	コネクタターミナル	
	40 10 00 LB 60 14 00	Connector Housing 6P	コネクタハウジング	
	40 10 00 LB 60 17 90	" 3P	"	
	40 10 00 LB 60 24 40	" 7P	"	

※ New Parts

